

Beachten Sie stets die technischen Angaben des Produktes, die auf dem Typenschild angegeben sind.

Always observe the technical specifications of the product as indicated on the type label.

FR RESPECTEZ TOUJOURS LES DONNÉES TECHNIQUES DU PRODUIT QUI FIGURENT SUR LA PLAQUE SIGNALÉTIQUE.

SK VŽDY DODRŽIAVAJTE TECHNICKÉ ÚDAJE O VÝROBKU UVEDENÉ NA TYPOVOM ŠTÍTKU.

CZ VŽDY DODRŽUJTE TECHNICKÉ ÚDAJE O VÝROBKU UVEDENÉ NA TYPOVÉM ŠTÍTKU.

HU MINDIG VEGYE FIGYELEMBE A TERMÉK MŰSZAKI ADATAIT, AMELYEK A TÍPUSÁBLÁN VANNAK FELTŰNTETVE.

IT RISPETTARE SEMPRE LE SPECIFICHE TECNICHE DEL PRODOTTO RIPORTATE SULLA TARGHETTA DI IDENTIFICAZIONE.

ES RESPETE SIEMPRE LAS ESPECIFICACIONES TÉCNICAS DEL PRODUCTO QUE SE INDICAN EN LA PLACA DE CARACTERÍSTICAS.

NL RAADPLEEG ALTIJD DE TECHNISCHE INFORMATIE OVER HET PRODUCT DIE OP HET TYPEPLAATJE IS VERMELD.

SV OBSERVERA ALLTID PRODUKTENS TEKNISKA DATA SOM FINNS PÅ TYPISKYLTEN.

SLO VEDNO UPOŠTEVAJTE TEHNIČNE PODATKE IZDELKA, NAVEDENE NA TIPSKI PLOŠČICI.

HR UVIJEK SE PRIDRŽAVAJTE TEHNIČKIH PODATAKA PROIZVODA KOJI SU NAVEDENI NA OZNAČNOJ PLOČICI.

RU ВСЕГДА СОБЛЮДАЙТЕ ТЕХНИЧЕСКИЕ ХАРАКТЕРИСТИКИ ИЗДЕЛИЯ, УКАЗАННЫЕ НА ФИРМЕННОЙ ТАБЛИЧКЕ.

UKR ЗАВЖДИ ДОТРИМУЙТЕСЯ ТЕХНІЧНИХ ХАРАКТЕРИСТИК ВИРОБУ, ЗАЗНАЧЕНИХ НА ЗАВОДСЬКІЙ ТАБЛИЧЦІ.

BG ВИНАГИ СПАЗВАЙТЕ ТЕХНИЧЕСКИТЕ ХАРАКТЕРИСТИКИ НА ПРОДУКТА, ПОСОЧЕНИ ВЪРХУ ТИПОВАТА ТАБЕЛКА.

PL NALEŻY ZAWSZE PRZESTRZEGAĆ DANYCH TECHNICZNYCH PRODUKTU PODANYCH NA TABLICZCE ZNAMIONOWEJ.

RO RESPECTAȚI ÎN TOTDEAUNA SPECIFICAȚIILE TEHNICE ALE PRODUSULUI CARE SUNT INDICATE PE PLĂCUȚA DE TIP.

VERWENDETE SYMBOLE SYMBOLS USED

FR SYMBOLES UTILISÉS **SK** POUŽITÉ SYMBOLY **CZ** POUŽITÉ SYMBOLY **HU** HASZNÁLT SZIMBÓLUMOK **IT** SIMBOLI UTILIZZATI **ES** SÍMBOLOS EMPLEADOS **NL** GEBRUIKTE SYMBOLEN

SV ANVÄNDA SYMBOLER **SLO** UPORABLJENI SIMBOLI **HR** KORIŠTENI SIMBOLI **RU** ИСПОЛЬЗУЕМЫЕ СИМВОЛЫ **UKR** ВЖИВАНІ СИМВОЛИ **BG** ИЗПОЛЗВАНИ СИМВОЛИ

PL UŻYTE SYMBOLE **RO** SIMBOLURILE UTILIZATE



Symbolerklärung hier

www.orionleuchten.at/symbole/





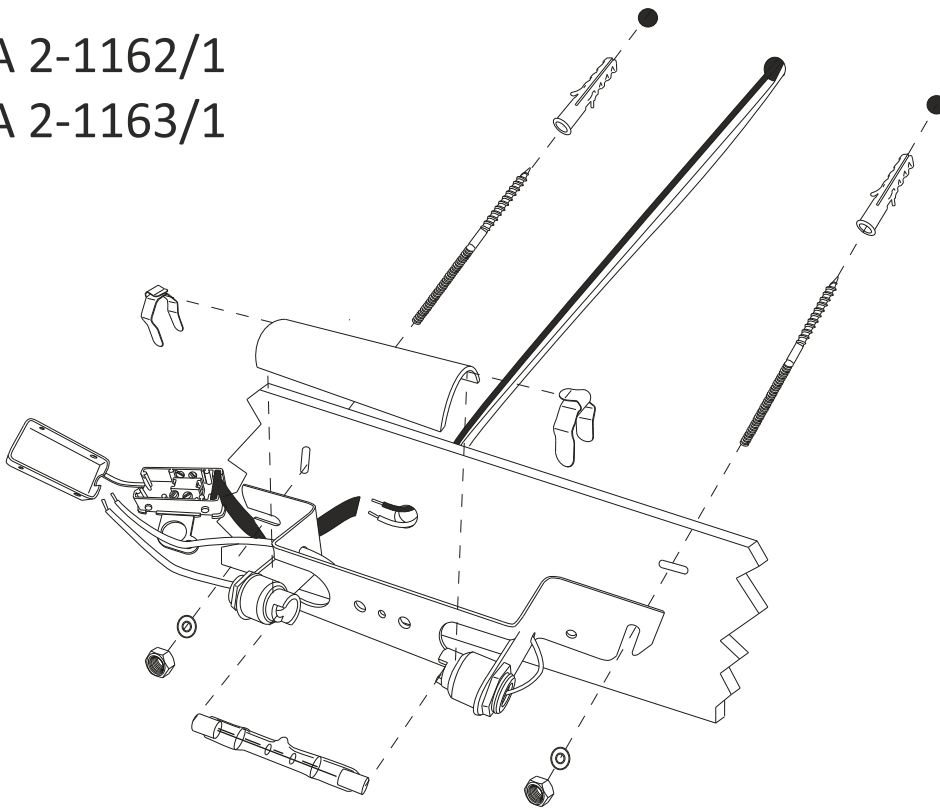

Explanation of symbols here

www.orionlightings.com/symbols/

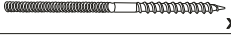
WA 2-1162/1
WA 2-1163/1

ORION LEUCHTEN
MIT STIL

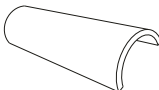

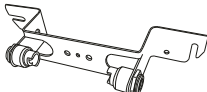
	x2	A
	x2	B
	x2	C
	x2	D
	x1	E
	x2	F
	x1	G
	x1	H
	x1	I

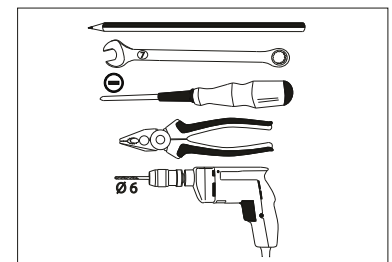

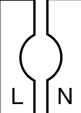
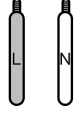
	L	Stromführender Leiter Live conductor
	N	Neutraleiter Neutral conductor
		FR CONDUCTEUR NEUTRE SK NEUTRÁLNY VODIČ CZ NEUTRÁLNÍ VODIČ HU SEMLEGES VEZETŐ IT CONDUTTORE NEUTRO ES CONDUCTOR NEUTRO NL NULLEIDER SV NEUTRALLEDARE SLO NEUTRALNI VODNIK HR NEUTRALNI VODIČ RU НЕЙТРАЛЬНЫЙ ПРОВОДНИК UKR НУЛЬОВИЙ ПРОВОДНИК BG НЕУТРАЛЕН ПРОВОДНИК PL PRZEWÓD ZEROWY RO CONDUCTOR NEUTRU

